

Article number: 203502451154NI

Description: E+G Levelling sets GN 350.2-45-11-54-NI

## Measures

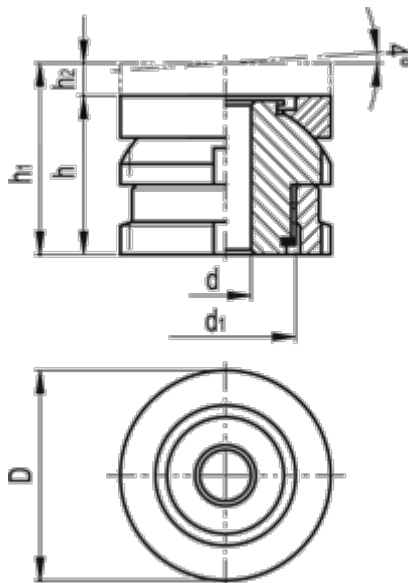

C-spanner DIN 1810 = A45-50

$d$  = 11

$D$  = 45

$d_1$  = M30x1.5

For screw = M10

$h$  = 54

$h_1$  = 79

$h_2$  = 25

Max static load (kN) = 84

Static preload (kN) = 64.01

Weight (g) = 553